

SIGMA P

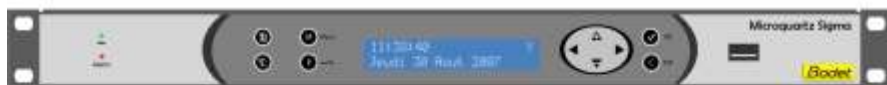

Installation and start-up instructions



B.P. 1
49340 TRÉMENTINES
FRANCE
Tél. : 02 41 71 72 00
Fax : 02 41 71 72 01
www.bodet.com



Réf.:606412 H

Check the product for shipping damage on reception for any reservations to the carrier

Table of contents

1) General.....	4
2) Safety rules	5
PROTECTIONS :	5
3) Description	7
4) Keypad: Key functions	8
5) Main menu programming	10
5.1 Standby state	10
5.2 User menu.....	10
5.3 USB loading and backup	11
5.4 Adding DHF receivers	12
5.5 Bank holidays	13
5.6 Access code	13
5.7 Time and date	14
5.8 Dynamic radio	14
5.9 Language	15
5.10 Version	15
6) Programming the circuits	16
6.1 Viewing the circuits.....	17
6.2 Programming the circuits.....	17
6.3 Deleting a program.....	19
6.4 Viewing the status of a circuit.....	19
7) Manual testing of circuits	20
8) Programming in Holidays and Special Day mode	21
9) Technician menu programming	23
9.1 Time synchronisation menu.....	24
9.2 Time output management menu.....	27
9.3 Relay setting menu.....	28
9.4 RHF circuit function setting menu.....	29
9.5 Function setting menu	30
9.6 “Delete all programming” menu	31
9.7 CPU software download menu	32
9.8 Factory setting restoration menu	32
10) Priority of execution of programs	33
11) Alarm messages	34
12) Installation	36
12.1 Mechanical installation	36
12.2 Electrical connections.....	37
13) Options	40
13.1 Mechanical installation	40
13.2 Option board with 3 AFNOR outputs	41

13.3 Option board with 2 ASCII outputs	42
13.4 Option board 24V //	44
13.5 Option board with 3 serial outputs	45
13.6 relay option board.....	47
13.7 Option board with AFNOR input	48
14) Technical characteristics.....	49
15) What to do if ...? Check that	51
16) Installation examples.....	52
16.1 Setting a 24V time distribution.....	52
16.2 Setting a DHF time distribution.....	52
16.3 Programming a RHF circuit	53
16.4 Install an option board	54
16.5 Set a 24V TBT output.....	54

1) General

The Sigma is a master clock which can be used to control receiver clocks and heating circuits, lighting, ringing, access at the doors of the building, etc.

The SIGMA has functions which can be programmed from the technician menu.

On first installation, it is essential to program the technician menu (see page 23) before the customer menu.

It is also essential when installing the SIGMA to program the technician functions in the order in which they appear in the menu.

This product must be installed in a residential, commercial or light industry environment.

Bodet declines all responsibility in the event of an accident resulting from use not in accordance with the recommendations of this manual.

CAUTION :

Any modification on the product renders the guarantee null and void.

Checking the equipment:

- One SIGMA master clock.
- One USB key,
- One CD containing the PC software.

The CD supplied with your unit contains a program allowing you to carry out the programming. The programming can thus be carried out simply on a PC and transferred via the USB port of the Sigma (see “USB loading and backup”, page 11).

To verify the model of the master clock, press the  key.



SIGMA P

2) Safety rules

- **Installation and maintenance of this equipment should only be carried out by qualified personnel.**
- If the SIGMA is connected to the 230 V mains power supply, its installation must comply with the European standard IEC 364 (NFC 15.100 for France).



PROTECTIONS :

- 110-230V version: the mains supply for this device must include a neutral phase circuit breaker of maximum 6 A C curve, rapidly accessible upstream from the supply.
- 24V DC version: the SELV 24 V power supply for this device must include a protection of maximum 6 A.
- 36-72V DC version: the SELV 36-72 V power supply (according to NFC 15-100) for this device must include a protection of maximum 6 A.



- For the relay circuits, add protections with circuit breakers of maximum 4 A. Indicate on the labels the location of these protections.
- The circuit breaker must be switched off during maintenance operation. Refer to labels in the product.
- All cables must be attached either to the wall (wall-mounted version) or to the frame of the cabinet (Rack version) before being connected to the various terminals strips, to prevent any pulling on these terminal strips. In addition, the wires of each terminal strips must be attached to each other to maintain the various isolations if an initial fault occurs.
- The time distribution cables must not run alongside high power mains cables (to avoid interference with communication between the SIGMA and the clocks).

- The SIGMA must be attached (to the wall or on its support) before being switched on.
- The “RACK” models must be mounted in 19” cabinet. These components will provide mechanical, electrical and fire protection (only the front panel may remain accessible).
- **IMPORTANT: before any installation, refer to the “technical characteristics” paragraph.**
- Think of making a backup of your programming on the USB key. In case of incident (breakdown, thunderstorm...), you will just have to restore the backup to start the time distribution again.



Caution :

- In case of replacement of the CR2032 battery, it is **IMPERATIVE** to respect the polarity following the opposite indications.
- There is risk of explosion if the battery is replaced by a battery of incorrect type.
- Dispose of used batteries according to the instructions of the manufacturer.



3) Description

Wall box

19" Rack

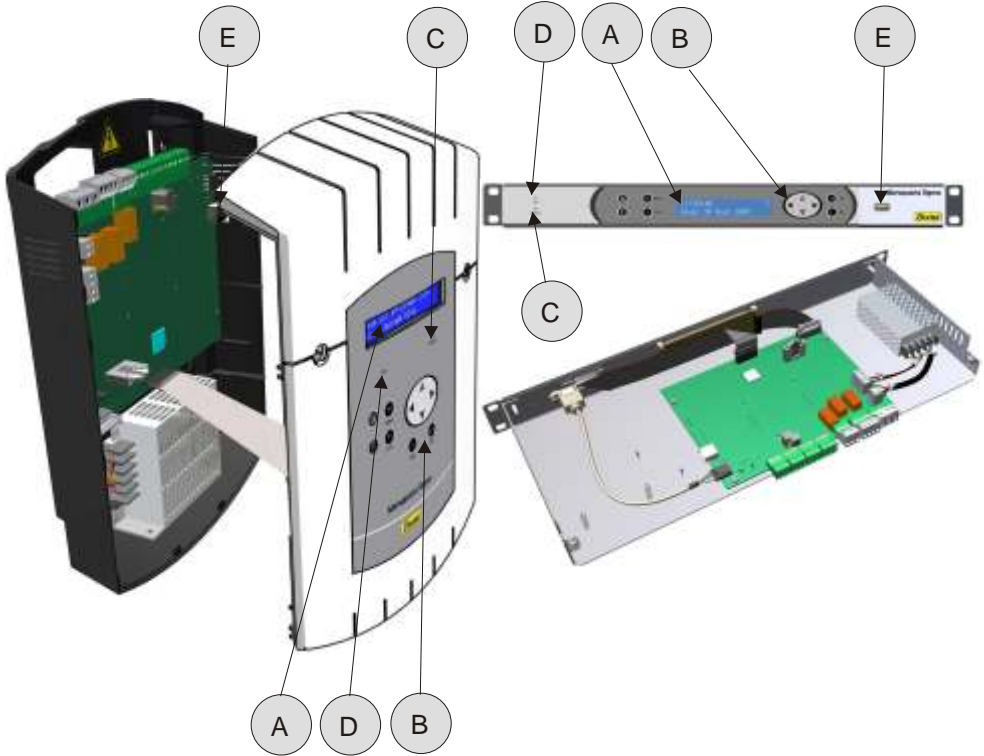

- A) LCD screen
- B) Keypad (see page 6)
- C) Alarm indicator light (red LED)
- D) Mains indicator light (green LED)
- E) USB connector
- F) Relay output terminal strips

4) Keypad: Key functions

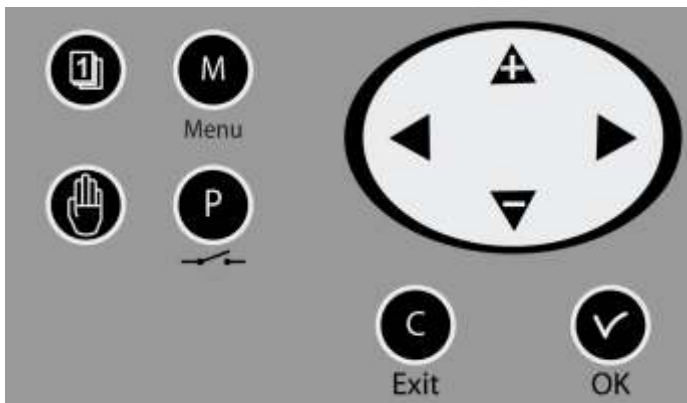

Keys

Functions



Calendar key.



Test key.



Menu key.



Program key.



Correction key.



Validation key.



, , , Navigation keys.

Note: exit from the menus is automatic if a key has not been pressed for one minute in the customer menu or for 5 minutes in the technician menu.

Synoptic diagram of the programming

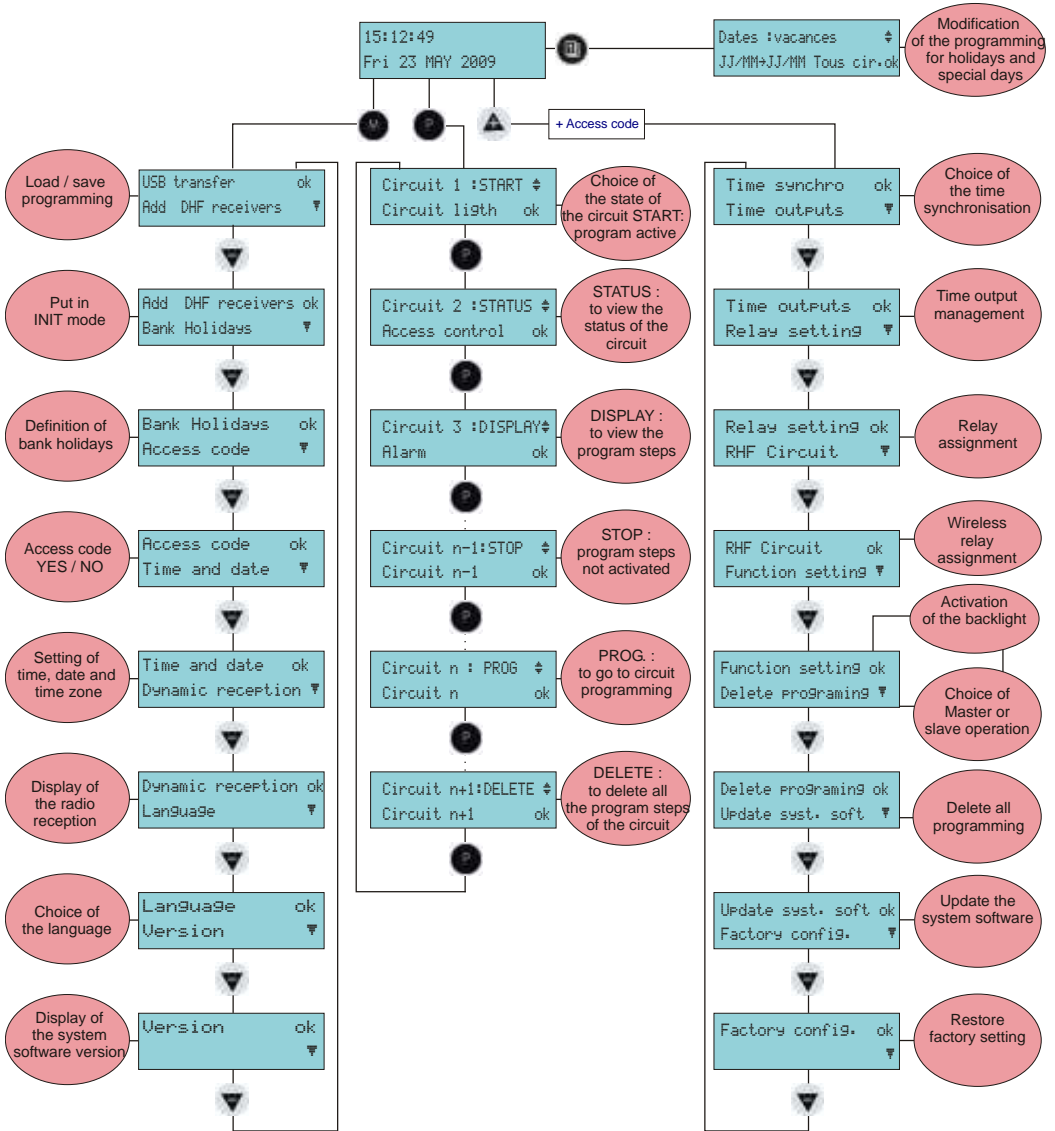

5) Main menu programming

5.1 Standby state

- In normal functioning the SIGMA displays the time and date :
ψ is the radio signal indicator, which flashes if reception is poor.
- If a bank holiday, a special day or a holiday period has been programmed on this given day, the SIGMA indicates this via a display during the period in which it applies, with priority management.



10:54:32 ψ
Fri 23 MAY 2008



10:54:32 BANK DAY ψ
Thu 25 DEC 2008





10:54:32 HOLIDAYS ψ
Mon 24 DEC 2008

5.2 User menu

To access the user menu, press the menu key  .
Enter the user access code if necessary
(see page 13).



USB transfer ok
Add DHF receivers ▾

Access the menu options using the 
key and validate with .

The user menu options are :

- 1/ USB loading and backup,
- 2/ Add DHF receivers,
- 3/ Bank holidays,
- 4/ Customer menu access code,
- 5/ Time and date / time changeover,
- 6/ View dynamic reception,
- 7/ Language choice,
- 8/ System version.

5.3 USB loading and backup

The SIGMA can load or back up its programming via a USB key.

Validate the option with the  key,

```
USB transfer      ok
Add D/F receivers  ▾
```

The following screen is displayed :

Insert the USB key and validate with the

 key.

```
Connect USB key then
Press ok           exit C
```

To load a Program in the Sigma :

Validate the option with the  key,

The SIGMA will search for the files available on the key (.sig extension).

```
Restore backup  ←
Create backup   →
```

Select the file to be loaded using the  and

 keys and validate with the  key.

The loading is then carried out. When it is completed, the unit displays :

```
Restore:Nest01.02#
Confirm ok      exit C
```

```
TRANSFER COMPLETED
REMOVE USB KEY
```

To back up the existing Program of the Sigma :

Validate the option with the  key,

The SIGMA saves the file with an automatically allocated name in the format: sauve1_DD_MM.sig (The number (1, etc.) and the date are incremented automatically).

```
Create back up
Confirm ok    exit C
```

It is possible to rename this file from the PC, while keeping the same ".sig" extension.

Once the backup is completed, the unit displays:

```
TRANSFER COMPLETED
REMOVE USB KEY
```

5.4 Adding DHF receivers

To place the SIGMA in “DHF initialisation” mode and enable synchronisation of a new clock, validate the initialisation mode with the

 key,

The following screen is displayed :

Select “ACTIVE” mode using the 

and  keys and validate with the

 key.

The “init” display mode will appear alternately with the normal display during this period (4 hours).

It is possible, once the receivers DHF initialized, to stop this mode in this menu.



```
Add DHF receivers  ok
Bank Holidays      ▼
```



```
Init mode:ACTIVE  ⇄
Add receivers     ok
```

5.5 Bank holidays

Bank holidays saved via the PC software (maximum 20 dates) are managed by SIGMA.

By default, French bank holidays are active.

Bank holidays can be added and configured through the PC software.

Validate the option with the  key,

```
Bank Holidays      ok
Access code        ▾
```

The following screen is displayed :

Choose YES / NO to activate the bank holidays calendar. Bank holidays will be considered to be Sundays (the weekly programming for Sundays will be used on bank holidays).

```
Bank Holidays:Yes⊕
Sunday prog activated ok
```

5.6 Access code

To enter or remove the SIGMA access code, validate the option with the

 key,



```
Access code      ok
Time and date    ▾
```

The following screen is displayed :

Choose the option you require and

validate it with the  key.

```
Access code  Yes ⊕
              ok
```

The access code is fixed,  ,  ,  ,  .

If there are 3 attempts with the wrong access code, an alarm message appears. The keyboard is locked for 10 minutes. It is possible to unlock it from the technician menu.

5.7 Time and date

To change the time or the date of the SIGMA, validate the option with the

 key,

```
Time and date ok
Dynamic reception ▾
```

The following screen is displayed :

You have access to the time zone selection.

```
Time zone :LONDON ⬆
(GMT + 0h00) ok
```

The time zone selection allows you to automatically manage winter/summer time changeovers.

If the zone is not available in the 20 pre-programmed towns or time zones, select "PROG" mode which is programmed in the technician menu.

```
Time zone :PROG ⬆
(GMT + 12h00) ok
```

"PROG" mode allows you to configure personalised time zone differentials and time changeovers.

By default it is in "PROG" mode.

The hour is flashing: set the hour using

the  and  keys and move on to

the minutes with the  key.

Proceed in the same way for the date.

```
Time 10:12:00 ⬆
Date 20/12/2007 ok
```

Validate with the  key. If the time has been changed, the seconds are reset to 0.

5.8 Dynamic radio

To view the dynamic reception of the SIGMA, validate the option with the

 key,

```
Dynamic reception ok
Language ▾
```

If the reception is correct, the time and date are constructed automatically.

If the SIGMA is synchronised by a GPS antenna, the time displayed is GMT.

```
GMT : 10:12
21/12/2007  exit C
```

If the SIGMA is synchronised by a France-Inter or DCF antenna, the radio time is displayed.

```
10:12
21/12/2007  exit C
```

5.9 Language

To select the language of the SIGMA, validate the option with the  key,

```
Language      ok
Version       ▾
```

Select the SIGMA display language from the different options available.

```
Language:ENGLISH ⬆
ok
```

The languages available are : FRENCH, ENGLISH, SPANISH, GERMAN, DUTCH, PORTUGUESE, NORWEGIAN, DANISH, ITALIAN, ...

5.10 Version

To view the version of the SIGMA, validate the option with the  key,

```
Version      ok
▾
```

The following screen is displayed :

```
SIGMA P      Version
U1.1B08 02/10/2009 ok
```

6) Programming the circuits

The Sigma P has three programmable (hard-wired) circuits allowing contacts (relays) to be activated. The option boards allow relays to be added. See circuit setting programming in the technician menu on page 28.

The programming circuit menu is accessed by pressing the  key.

The programming can be carried out simply on a PC and be imported via the USB port of the Sigma (see “USB loading and backup”, page 11).

The configuration of the circuits can be displayed at any time.

Assignment of the relays as a programming circuit or as a melody output is carried out in the technician menu.



Depending on this assignment, the relay number is therefore a control circuit (no. 1 to 3) or an HF relay circuit (no. 60 to 75) or an HF melody control circuit (no. 60 to 75 with a musical note pictogram).

On this screen, you see the first circuit, its status (Start or Stop) and the name of this circuit on the second line.







```
Circuit 1 : START   
Circuit length ok
```

To view the various circuits, press the  key successively.

Use the  and  keys to select the mode of the circuit.



Description of circuit statuses :

- STOP : program steps not activated.
- START : program active.
- DISPLAY : to view the program steps without modifying them.
- PROG. : to go to circuit programming.
- DELETE : to delete all the program steps of the circuit.
- STATUS : to view the status of the circuit.

To change the name of the circuit, use the  key. Use the  and  keys to select the characters of this text and validate with the  key.



6.1 Viewing the circuits

Select the number of the circuit you wish to view with the  key.

Select VIEW mode with the  and  keys and validate with the  key .
The display of the parameters is fixed and the step numbers flash.



```
Cir. 1:08:02:00 03s
MTWTF-- Weekly 01/12
```

The  and  keys can be used to scroll all the program steps.

Use the  key to exit from the menu at any time.

The program steps are displayed in the order of the times and then by type: weekly order, holidays, special and then PC step.

Steps 01 to 99 are indicated with the total number of steps; if the step is greater than 99 then only the step number from 001 to 500 is displayed.

6.2 Programming the circuits



Select the number of the circuit you wish to program, or modify the programming with the  key.

The circuits can be programmed in the following modes:

- Weekly,
- Holidays,
- Special,
- Additional step,
- Astronomical,
- Periodic.

Only the first 3 modes are accessible from the master clock. All the modes are accessible from the PC software.

Select PROG mode with the  and  keys and validate with the  key. If the first step is blank, the time flashes.



Enter the time with the  and  keys and then validate with the .

```
Cir. 1:HH:MM:SS ---#  
MTWTFSS- Weekly 01/01ck
```

Proceed in the same way for the minutes and then the seconds.

Enter the status of the circuit for this program step, choosing from ON, OFF, 01s (length in seconds which can be set



```
Cir. 12:08:02:00 ---#  
MTWTFSS- Weekly 01/01ck
```

using the  and  keys) and DEL (DEL mode is used to delete the selected step), and then validate with the  key.

If the circuit is a melody circuit, you have to select the melody number and the number of times it must be played (from 1 to 4).

```
Cir. #61:08:02:00 #02x1  
MTWTFSS- Weekly 01/01ck
```

The validation with the  key allows to move on to the second line.

Select the days on which this program line will have to apply using the  and  keys and then select the mode, choosing from:

WEEKLY: WEEKLY mode functions all year with application of bank holidays if programmed.

HOLIDAYS: HOLIDAYS mode stops weekly (and bank holiday) mode for a programmed period and activates the programming of the relays with HOLIDAYS mode.

SPECIAL: SPECIAL mode deactivates weekly and holidays mode and starts the steps in SPECIAL mode.

Validate the step with the  key.

If you have programmed a length, the value in seconds is stored and proposed for the next step.

```
Cir. 12:08:02:00 03s#  
MTWTFSS- Weekly 02/02ck
```

NOTE: you can press the  key on the first step of the program or on the time parameter to access the previous step or a blank step. On the last step, it allows you to add a new step or correct a previous step.



In this new step, press the  key to restore data from the first line of the previous step.

The program steps can be entered in any order. After validation, the system will reorganise the steps by time and then by type.

6.3 Deleting a program

Select the number of the circuit you wish to delete using the  key.

```
Circuit 12: START ⚡  
Access control ok
```



Select DELETE mode with the  and  keys and validate with the  key. After validation, all the steps of the program are deleted.

```
Circuit 12:DELETE ⚡  
Access control ok
```

6.4 Viewing the status of a circuit

Select the number of the circuit of which you wish to view the status with the  key.

```
Circuit 12: START ⚡  
Access control ok
```

Select STATUS mode with the  and  keys and validate with the  key.

```
Circuit 12:DISPLAY⚡  
Access control ok
```

You will see the theoretical status of the programming circuit: ON, OFF, FORCED ON (if the circuit is forced manually to ON) or ACTIVE (if an action is in progress).

7) Manual testing of circuits

While the status of a relay is displayed, it is possible to test it.

Select the circuit you wish to test with the

 key.

```
Circuit 12: START #
Access control  ok
```

The system recognises its mode of assignment (relay or melody).

If the circuit is a relay circuit, start the test

with the  key.



```
Cir.12: START TEST
Access control  ok
```

If you press it briefly (for less than 3 seconds), the relay is activated (ON position) for as long as the key is pressed.

If you press it for a longer period (more than 3 seconds), the relay is activated (ON position), and if you press it again the relay is deactivated (OFF position).

If the circuit is a melody circuit,

You can select the melody to be tested

with  and  keys.

Start the test with the  key.

```
Cir.#12: START MEL01
Access time     ok
```

If you press it briefly (for less than 3 seconds) = the melody is played once.

If you press it for a longer period (more than 3 seconds) = the melody is played loop until you press it again.

```
Cir.61# : FORCED TEST01
STOP TEST :  ok
```

8) Programming in Holidays and Special Day mode

The programming of the SIGMA can be modified during a holiday period and for a special day.



To access this menu, use the  key.

It is possible to enter dates for a holiday period or for a special day. By default, Holidays mode flashes.

Select Holidays or Special mode, and

then validate with the  key.

The first date flashes.

Enter the dates with the  and 

keys and then validate with the  key.



```
Dates : Holidays ⚡  
10/02-25/02 All Circ.ck
```

You can enter only one date-to-date series in Holidays mode on the unit, but it is possible to enter 20 periods with the software on the PC.

Only the next period can be accessed and modified using the Sigma keypad.

If only the start date is entered (= 1 day), then the start date is the same as the end date.

If the start date is not entered and only the end date is entered, the programming is not executed.

It is possible to choose Holidays or Special application mode on all the circuits in a single operation.

If the "ALL CIRC." Option is validated, the Holidays (or Special Day) mode will apply on all the circuits or melodies of the master clock.



```
Dates : Holidays ⚡  
10/02-25/02 All Circ.ck
```

If the "SELECT" or "ALL EXCEPT" option is validated, it is then possible to enter the circuit numbers concerned by

this programming either by selecting them one by one or by omitting them ("all circuits except").



```
Dates : Holidays ⚡  
10/02-25/02 SELECT ck
```

You must then select the circuits concerned.

```
CIR ← 12/20/21# /---→  
circuit heating  ok
```

Scroll all the circuits with the ◀ and ▶ keys and validate with the ▼ and ⚠ keys if they are concerned by the holiday period.

If the “ALL EXCEPT” option is validated, only the selected circuits will not be affected by the Holidays mode.

```
Dates : Holidays #  
10/02-25/02 All excep ok
```

```
CIR →12/20/21# /---→  
circuit heating  ok
```

9) Technician menu programming





The technician menu is accessible via an access code sent to the approved persons.

Press one of the navigation keys for a few seconds.



A code is then requested.



Enter TECHNICIAN code

The technician code is a fixed code, , , ,  and .

You then have access to the technician menu,

Validate the required option with the  key, or access the following options with the  key.

The options in the technician menu are :



Time synchro ok
Time outputs ▾

- 1/ Time synchro,
- 2/ Time output and DHF management (impulses, D1 D2, Afnor, DHF) and output time zone differential,
- 3/ Alarm and D1 D2 relay assignment,
- 4/ RHF box assignment,
- 5/ Function assignment,
- 6/ Delete all programming,
- 7/ CPU hardware software download (.cod extension),
- 8/ Restore factory configuration.

Validate the required option with the  key.

To exit the technician menu, press the  key.

9.1 Time synchronisation menu

To configure the time synchronisation of the SIGMA, validate the option in the technician menu with the  key, The following screen is displayed :
Select the time synchronisation mode from the following options:

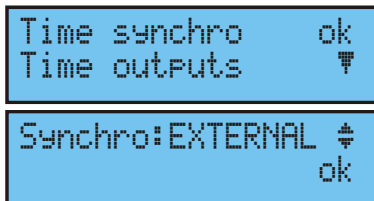

Radio FI/DCF,

Minute radio (mode used for countries receiving the FI/DCF radio signal but for which the time is different from Paris/Berlin [only minute is synchronised, date and hour must be set manually]),

EXTERNAL (mode used for synchronisation from a Sigma “Master” which transmits a GPS signal simulation from an ASCII extension card),

NONE: if you choose to have no synchronisation, the radio pictogram is not displayed.

GPS,

AFNOR (requires an option board),

ASCII (requires an option board),



Auto (the master clock will select the best time source automatically; in that case, several time sources can be connected to the master clock; it will change time source in case of failure of one of them; the priority is given at first to AFNOR then GPS, FI / DCF).

Remark : all the synchronisation options are proposed without checking that an antenna is connected (by default, the configuration is FI/DCF mode).

In case of synchronisation input failure, an alarm message is sent.

This alarm is triggered after 3 hours without synchronisation in Auto mode, after 24 hours in the other synchronisation modes.



Select the synchronisation mode with the  and  keys and validate with the  key.

The following screen is displayed if “Prog” mode has been validated in the customer menu (see “Time and date”, page 14) :







This menu can be used to program non-standard winter/summer time changeovers.

9.1.1 Programmable time changeover

This menu can be used to program the summer/winter time changeover dates. It allows you to define the start of the winter period and then the start of the summer period.



To program the summer/winter time changeovers, validate with the  key.

- Set the start date of the winter period using the  and  and  key.



In order:

The “Rank” flashes. The Rank designates the order number of the day of the week in the month¹ (1 to 5 depending on the month) (rank 5 always indicates the last week).

The “day” flashes.

The “month” flashes.



The “time” flashes.

Validate with the  key.

- Set the start date of the summer period



¹ Example of Rank calculation: the second Monday of the month or the second Thursday of the month have rank “2”, while the last Tuesday of June has rank “5” as there are no more than 5 weeks in a month.

using the  and  and .

Validate with the  key.

Whatever the synchronisation mode (radio France Inter or GPS), this forces the automatic time changeover for radio FI or DCF.

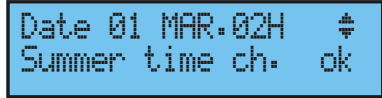

Set the start date of the winter period and then the summer period using

 and  and  keys.

Validate with the  key.

9.1.2 Setting the time base

This menu can be used to set the drift of the time base. This can be useful when the master clock has no external synchronisation.

To access this menu, you need to have selected "None" mode in the external synchronisation menu.

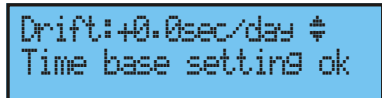

Set the drift using the  and  keys

and validate with the  key.

9.2 Time output management menu

Programming by PC software allows the time zone differential of each output to be set with respect to the local time.

This menu can be used to view all the time outputs, modify their status (Start/Stop), configure the DHF distribution in Init mode and configure the “impulse” and “D1D2” distribution.

This menu allows you also to configure the impulse output (Impuls 01) to provide TBT 24VDC (1A) power supply.

To go to the SIGMA time output management menu, validate the option in

the technician menu with the  key,

```
Time outputs      ok
Relay setting     7
```

The following screen is displayed :

You can view the different options and

change the values using the  and

 keys.

```
Impuls 01:MIN 1.2s 4
START 00:00        ok
```

You can go through the different outputs

```
Afnor 02:  START 4
                        ok
```

by validating using the  key.

The 3 outputs (Impulse 01, Afnor 02 and DHF03) are not programmable with a time zone differential.

The placing of a DHF output in “INIT” status is active for 4 hours before return to START mode (The init mode display is alternating with the normal display during this period).

```
DHF 03 :  INIT 4
125mW channel:1 ok
```

This menu can be used to set the power of the DHF output with a choice of 25mW / 125mW (by default) / 500mW and assign the system address from 1 to 4 (1 by default).

Buzzer mode allows you to activate a buzzer on the secondary transmitters in order to identify them.

For an “impulse” or “D1D2” output, the

 key can be used to go to the configuration menu.

```
D1D2 minute:06s 4
START 00:00      ok
```

Remark: the “D1D2” menu appears only if the relays have been assigned to the D1D2 distribution (see “Relay setting menu”, page 28).

Use the  key to move on to the next parameter:
Choice of impulse length.

- Minute 24V standard impulse length (factory configuration) of 1.2 seconds variable from 0.5 to 5 seconds,
- Second 24V standard impulse length (factory configuration) of 0.3 seconds variable from 0.1 to 0.9 seconds,
- D1D2 standard impulse length (factory configuration) of 6 seconds, variable from 1 to 10 seconds.

Use the  key to move on to the next parameter:
Choice of status (“Start”/“Stop”).
Circuit stopping must be confirmed.



```
Caution STOP mode ok
on D1D2 output      C
```

Use the  key to return to the previous screen.

9.3 Relay setting menu

This menu can be used to assign the relays (D1D2 and alarm).

To go to the SIGMA relay assignment menu, validate the option in the

technician menu with the  key,

The following screen is displayed :



```
Relay setting      ok
RHF Circuit
```

By default, relay 3 (R/T relay) is assigned to the “Alarm” output and relays 1 and 2 (T relays) to the D1D2 time distribution.



```
Rel 03 alarm :Yes +
                        ok
```

Nota: when no alarm is active, the alarm relay is set to ON.

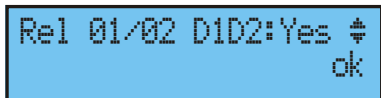

```
Rel 01/02 D1D2:Yes +
                        ok
```

To allow them to be used for another function (control of heating, lighting,

etc.), these relays must be set to No in this menu.

The relay option boards are recognised immediately on connection in the SIGMA. If the board is removed the programming is retained. It is deleted either with the PC software or in the technician menu with the “Del.” option.

The assignment of the hard-wired relays is automatic. If a relay board is connected, the 3 relays will be defined according to the following logical output number :

- Slot 1, relays 4, 5 and 6,
- Slot 2, relays 7, 8 and 9.

9.4 RHF circuit function setting menu

This menu can be used to assign the HF relays (16 address² maximum). To go to the SIGMA relay setting menu, validate the option in the technician menu with the  key,

```
RHF Circuit      ok
Function setting 7
```

The following screen is displayed :

```
CIR.RHF:60 > MEL A 7
ok
```

Assign the RHF circuits to melody, relay or — (not present) mode, MEL, REL, or, —.

```
CIR.RHF:60 > REL 7
ok
```

The RHF circuits are declared from 60 to 75.

2 *Remark: several relays can be configured on the same address (for example for the same external lighting control).*

9.5 Function setting menu

This menu can be used to define whether the master clock functions as a master or as a secondary clock (slave).

It can also be used to activate the backlight of the display screen.

To go to the SIGMA function setting menu, validate the option in the

technician menu with the  key,

```
Function setting ok
Delete programming ▾
```

The following screen is displayed :

The master clock is configured in master mode by default.

```
Function : MAIN  ⬆
                                     ok
```

If you configure it in “slave” mode to assign it as a secondary master clock,

then the external input (see below) displays SLAVE and cannot be modified.

```
Function : BACK-UP ⬆
                                     ok
```

Select a circuit for the external input; the relays proposed are the relays which have been assigned.

In general, the external input will control a circuit dedicated to this alarm ringing function, relay ON

```
Ext input : CIR1  ⬆
FORCED ON        ok
```

Choosing the mode (START, LENGTH or FORCED ON) allows you to configure the input for its functioning and the period of functioning in this state.

START: starts the programming of the circuit concerned the first time it is pressed and stops it the next time (alarm type message on the display indicating the external input (circuit 1) and its status (ON, OFF or START).

```
Ext input : CIR1  ⬆
START            ok
```

LENGTH starts the relay in ON mode during the programming period HH MM SS; pressing Enter places the circuit in stop mode.

FORCED ON: forces the relay position whatever the programming (as in test mode); 1st pressing ON, 2nd pressing OFF.

```
Ext input : CIR1  ⬆
LENGTH HH:MM:SS  ok
```

A switch can be placed on the output to configure the status of the input as ON or OFF permanently.

The following screen can be used to activate or deactivate the idle screen backlight (by default, the backlight is lit, therefore value set to No).

```
Backlight off : NO  ⬆
                                     ok
```

9.6 “Delete all programming” menu

This menu can be used to delete all the programming.

To go to this SIGMA menu, validate the option in the technician menu with the  key,

```
Delete programming ok
Update syst. soft  ⬇
```

The following screen is displayed :

```
Delete all prog:Yes⬆
                                     ok
```

To delete, validate with the  key,

```
Confirm delete  ⬆
all programs    ok
```

9.7 CPU software download menu

This menu allows you to update the system software of the master clock.
To go to this SIGMA menu, validate the option in the technician menu with the  key,

```
Update syst. soft ok
Factory config.  ▾
```

The code file (*.cod) must be on the root of the USB key and be the only ".cod" file.

The following screen is displayed :
to download,

```
Connect USB key then
press ok      exit C
```

validate with the  key,

```
Reading USB
in proces .....
```

The following screen is displayed :
validate with the  key,

```
Confirm syst. soft ok
update                C
```

```
Transferring
Stage 01 .....
```

9.8 Factory setting restoration menu

This menu can be used to reinstall the initial factory setting.
To go to this SIGMA menu, validate the option in the technician menu with the  key,

```
Factory config. ok
▾
```

The following screen is displayed :
To reinstall the factory configuration,
validate with the  key,

```
Restore config : No  ⚡
factory configuration ok
```

10) Priority of execution of programs

Function	Priority
Circuit 1 in alarm, circuits 2 and 3 in time distribution (D1D2 tower clock)	1 (high)
Manual control of relays	2
Manual selection of a particular day (bank holiday / day before bank holiday / special day)	3
Programmed special day	4
Programmed holidays and bank holidays	5
Weekly program	6 (low)

When the Sigma is configured in one of the modes, all the program steps of the lower-priority modes are ignored.

The “astronomical” and “periodic” modes, which are accessible only via software programming on a PC, do not have high priority (the astronomical, periodic and weekly modes, which will rarely be programmed together on the same circuit, are lumped together at low level).

11) Alarm messages

By default, the alarm configuration is :

- Activated: if an alarm is present, a message is displayed on the readout,
- Alarm relay: relay 3 is activated if an alarm is triggered.

If the display of alarms was selected by the installer at the time of configuration of the unit (See Alarm configuration, page 28), the SIGMA can display alarm messages :

If an alarm is active, the display alternates between the date and the alarm message.

Press the  key to view additional information on this alarm.

Example :

```
10:54.32      ψ  
Alarm :output 01 ▶
```

If several alarms are active simultaneously, the display is:

Press the  key to view the additional information.

Press the  key to view the following alarms.

The alarms are displayed in chronological order.

```
24v overload on 01  
18/12/07 10:54.32 ok
```

```
10:54.32      ψ  
Alarmes      ▶
```

```
Alarm :output 01 ▶  
Alarm :output 03 ▾
```

To acknowledge an alarm, press .

Except for Afnor, FI, DCF and GPS synchronisation failures where alarm is activated after 24 hours, other alarms are activated immediately.

Alarm message	Meaning
user code fail.	The user code has been entered three times incorrectly; the keyboard is blocked for 10 minutes.
tech.code fail.	The technician code has been entered three times incorrectly; the keyboard is blocked for 10 minutes.
battery failure	The lithium battery used to save configuration data is defective; replace the battery after making a backup of configuration data.
24V bat.failure	The 24V power supply is faulty; check the 24V battery backup.
master failure	The main master clock is defective; control the main master clock. If a Sigma SWITCH is used, the stand-by master clock will automatically take over.
sync. failure	The synchronisation source is faulty. In case of synchronisation input failure, an alarm message is sent. This alarm is triggered after 3 hours without synchronisation in Auto mode, after 24 hours in the other synchronisation modes.
24V overload	The impulse line is overloaded; check the impulse line or reduce the number of clocks.
24V pulse fail.	The impulse output is defective.
Afnor failure	The AFNOR output is defective.
Ascii failure	The ASCII output is defective.
DHF failure	The DHF output is defective.
series puls.fail.	The series impulse output is defective.
SC. series pulse	The series impulse line is overloaded or short-circuited.
OC. series pulse	The consumption on the series impulse line is too high.
Circuit failure	The relay extension card does not answer; check the presence of the card.
Afnor sync. failure	The AFNOR synchronisation source is faulty.

12) Installation

12.1 Mechanical installation

Choose a room with low temperature variations away from any source of electrical interference (contactors, motors, etc.).

WALL-MOUNTED version: Unscrew the 2 screws on the front, remove the cover (for the lower cover, press on the 2 clips (N) and slide it upwards). Disconnect the flat jumpers (Q) (be careful to connect them the same way round on reassembly) and attach the SIGMA to the wall. When your unit is in place, remove the protective film on the keypad.

RACK version: Install the rack in its slot in an electrical bay or cabinet.

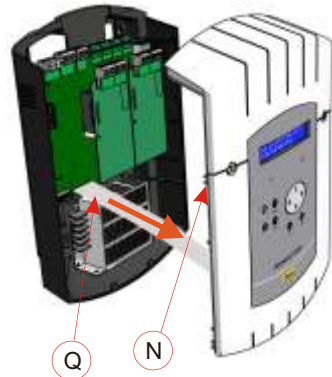

12.2 Electrical connections

Connect the cables (mains power supply, impulse line or AFNOR output and radio synchronisation input, depending on the model) to the corresponding terminal strips as shown in the figure below.

See the limit characteristics of these circuits on page 49.

(**)110 to 230VAC or 24VDC or 36/72VDC

Circuit C1

Circuit C2

Circuit C3

GPS input

F-I or DCF radio input

(*) Minute, ½ mn or second 24V

Afnor output

DHF output

External input

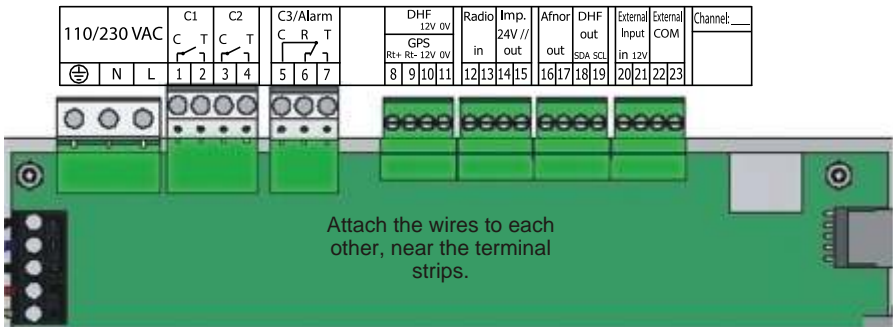

(*) See page 27, the “Time outputs” menu to set this output (Pulse minute, ½ minute, second 24V or power TBT 24VDC 1A).

(**) Power supply depending on the version of SIGMA master clock.

RACK version: The mains power supply, impulse line and AFNOR output and radio synchronisation input terminal strips are directly accessible at the rear of the Rack slide-in unit.

Connection for D1D2 distribution :

D1 D2 uses the relays of circuits 1 and 2

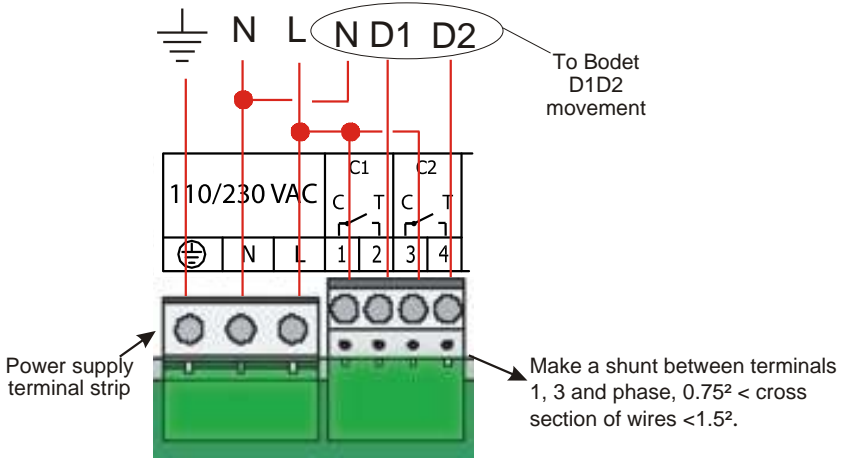

Circuits must be protected by fuse disconnecter or circuit breaker 4A maximum. Indicate on the label above the terminal block the location of these protections.

Connection of DHF transmitter :

There are two types of DHF transmitters.

DHF transmitter “Time and relays”, reference 907511, for SIGMA master clocks.

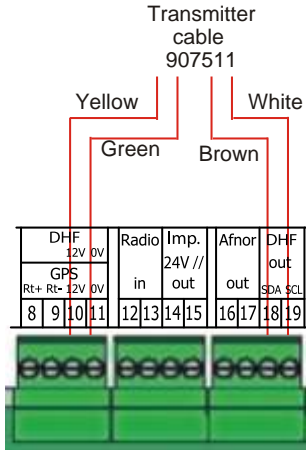

DHF transmitter “Time”, reference 927240, for master clocks SIGMA, DELTA, ALFA, etc.

Note: the INIT mode must be activated directly from a DIP switch on the electronic card of this transmitter (not from the master clock).

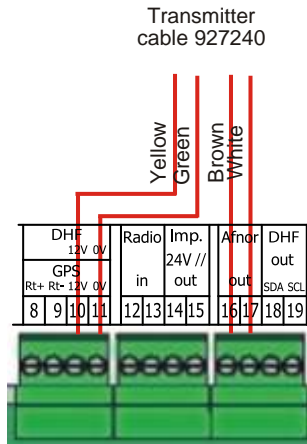

13) Options

The Sigma can be fitted with 2 option boards to extend its capacities. The option boards are installed “cold” and are automatically recognised when the master clock is switched on. The option boards are programmed with the software on PC.

13.1 Mechanical installation

WALL-MOUNTED version: Unscrew the 2 screws on the front, remove the cover (for the lower cover, press on the 2 clips (N) and slide it upwards). Disconnect the flat jumpers (Q) (be careful to connect them the same way round on reassembly) and install the option board(s) in the slots provided (X1) and (X2). Stick labels in front of the card. For relay cards, stick only the safety label.

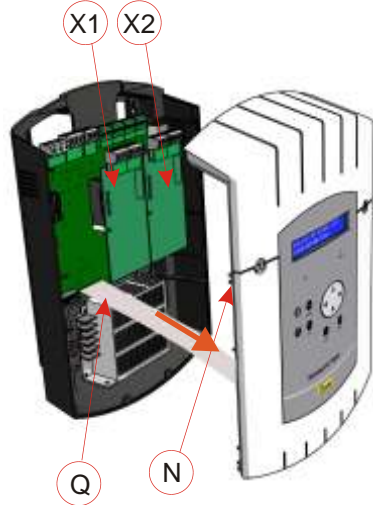

RACK version : Open the rack unit and install the option board(s) in the slots provided (X1) to (X2). Stick labels in front of the card. For relay cards, stick the safety label on the upper cover.

13.2 Option board with 3 AFNOR outputs



This option board does not require any software programming (by default the time is the local time defined in the Sigma and the line is stopped). Only the time zone differential and the state of the line (On / Off) is to be defined in the “Time outputs” technician menu (see page 27).

Connect the clock lines on outputs A, B and C.

Each output allows up to 50 clocks to be synchronised over 30 km.

Remark: the 3 outputs supply the same time. To have time distribution lines with different times, they must be programmed on different option boards.

If a short-circuit is detected on the line, an “AFNOR fault” error message is displayed (if the programming permits) on the readout of the master clock. If an AFNOR board occupies a slot, it takes the corresponding output numbers (Slot number + 3 (3 corresponds to the first 3 outputs already assigned)) with a letter ABC. For example, if a board with 3 AFNOR outputs is placed in slot 1, the outputs will be 4A, 4B and 4C (useful for alarm information).

Remark: in the “Time outputs” technician menu, “DEL” mode is used only to uninstall an option board from the master clock.

13.3 Option board with 2 ASCII outputs

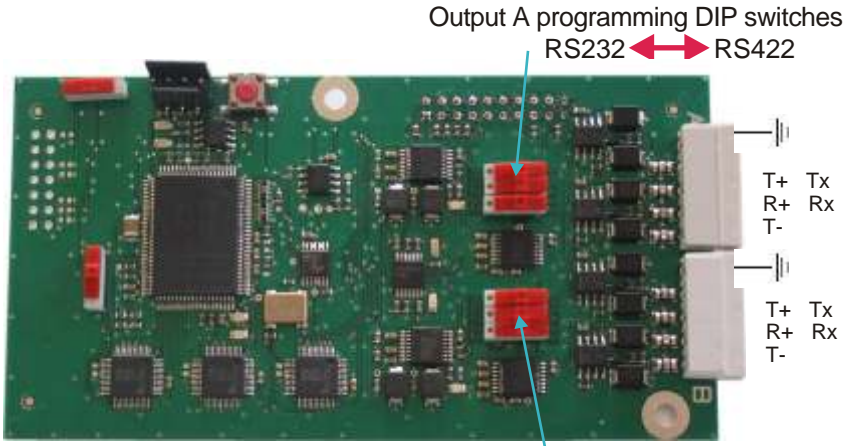

Output B programming DIP switches
RS232 ↔ RS422

This option board has 2 ASCII outputs which can be configured in RS232 or RS422 (RS485) mode. To change the configuration, push the 3 DIP switches to the desired position.

Connect the lines on outputs A and B.

The ASCII frame, the speed and the number of bauds are programmed on PC using the software.

The default programming is periodic sending of a message to Bodet switchboard 1 every second, at 9600 bauds, on 8 bits with no parity and 1 stop bit, and the time is the local time defined in the Sigma.

Different transmission frames available :

	Message content	Example
		Thursday October 9, 2008 at 15h 12m 30s
Standard 1	T:AA:MM:JJ:NJ:HH:MM:SS "x0D" "x0A"	Start of message: 08:10:09:04:15:12:30 "end of frame"
Standard 2	"x02" 00 JdS JJ/MM/AA HH:MM:SS "0D"	"Start of message" 00 Thu 09/10/08 15:12:30 "end of frame"
ZDA GPS simulation	\$GPZDA,HHMMSS,00,JJ,MM,AA, 00,checksum,"x0D" "x0A"	"Start of ZDA GPS message" 151230,00,09,10,08,00,00":6, "end of frame"
GGA GPS simulation	\$GPGGA,HHMMSS,00,code GGA, ,checksum,"x0D" "x0A"	"Start of GGA GPS message" 151230,00, llll.ll,a,yyyy.yy.a,1,xx,x.x,x.x,M,x.x,M,x.x .xxxx70"end of frame"
Prog.	Your programming: see help  button.	

Connection to a PC in RS232 mode

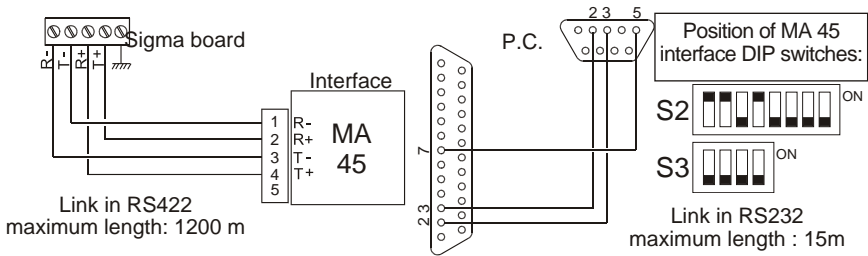
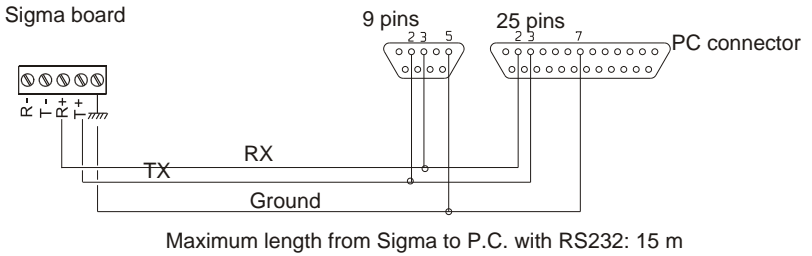

Synchronisation connection to a PC in RS422

Synchronisation connection to a PC in RS485

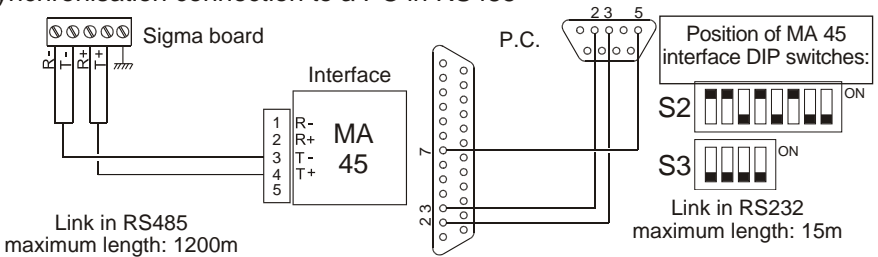

Set the lines to “On” in the “Time outputs” technician menu (see page 27.

Remark: in this menu, “DEL” mode is used only to uninstall the option board from the master clock.

13.4 Option board 24V //

Jumper to adjust maximum amperage
1A ← → 0,5A



This option board does not require any software programming.

It allows to add a minute, ½ minute, second or SR2-59 impulse output or TBT 24V DC 1A power supply. See page 27, the menu of the time outputs to set this output.

The jumper allows to adjust the maximum amperage of the output.
Caution: the maximum amperage will depend on the version of SIGMA master clock.

Version of SIGMA	Power	Max. amperage
110V/240V	35W	1A total 0.5A cpu + 0.5A option or 1A option
TBT 24V fixe	-	2.5A total 0.5A cpu + 2x1A option
TBT 36/72V	50W	1.5A total 0.5A cpu + 2 x 0.5A option or 0.5A cpu + 1A option

13.5 Option board with 2 serial outputs

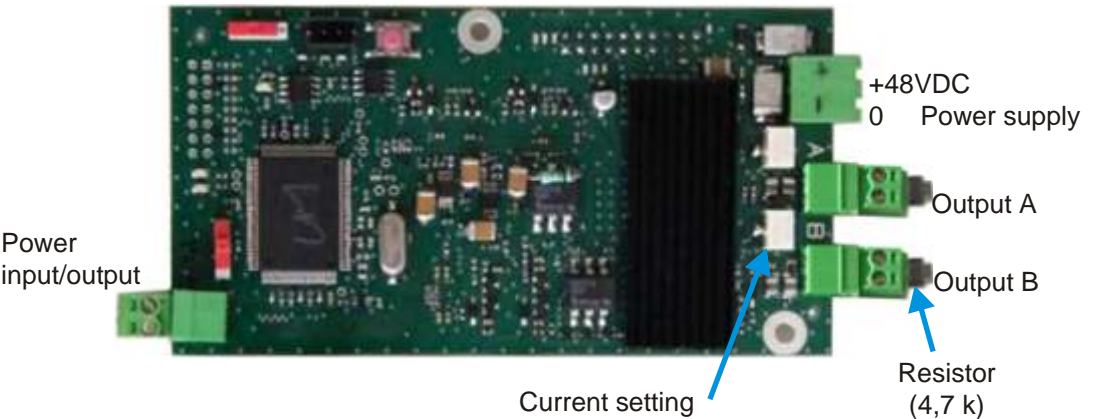

This option board does not require any programming. By default the time is the local time defined in the Sigma, with 1.2-second impulses, and the line is stopped.



Connect the 48VDC power supply to the 48VDC input of the card and the clock lines to the outputs A and B.

The current can be adjusted (from 50 to 100 mA) for each line, using the potentiometer next to each terminal strip.

The (4.7 K) resistor on each output terminal strip is designed to prevent the "line open" alarm message. It must be left if the line is not used.

Set the lines to "On" in the "Time outputs" technician menu (see page 27).

Resetting to the correct time can be carried out line by line.

In the time output management menu of the technician menu, use the  key to move to "set dial" and validate with , The following screen is displayed :

```
Impuls 05:1/2M 1.2s ⚡
STOP set dial ok

Dials : A:00:00 ⚡
        B:00:00 ok
```

Enter the time of the clocks for each line (line A and B), and then validate with ,

```
Dials : A:10:10 ⚡
        B:11:30 ok
```

Set the lines to "On".

You can view the various distribution lines of the board by selecting "view dial".



```
Impuls 05:1/2M 1.2s
START display dial ok
```

Remark: in the "Time outputs" technician menu, "DEL" mode is used only to uninstall the option board from the master clock.

13.6 relay option board



This option board does not require any software programming. It allows 3 relays to be added.

See the technician menu (circuit setting programming) on page 28.

Remark: in the time output management menu of the technician menu, “DEL” mode is used only to uninstall the option board from the master clock.

Examples of wiring

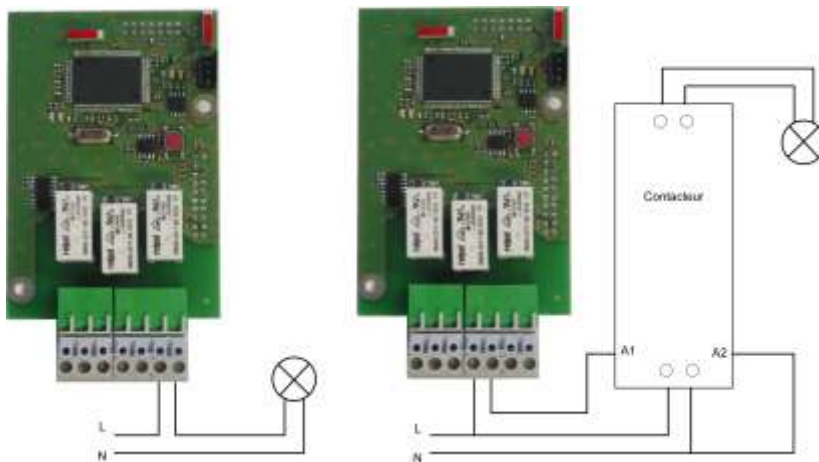

13.7 Option board with AFNOR input



This option board does not require any software programming.

It allows to add an AFNOR synchronisation input.

See “Time outputs” in the technician menu page 24.

14) Technical characteristics

	Designation	Characteristics
Electrical	Backup	Permanent backup of all parameters in case of mains failure. Automatic resetting of receiver clocks to correct time after mains restoration.
	Time base	Quartz, accuracy 0.1 seconds per day between 20 and 25°.
	Capacity	500 program steps per circuit.
	Power supply	115 or 230 V AC \pm 10% 50/60 Hz or 24 V DC, or 36/72 VDC (depending on the model).
	Maximum consumption	35W.
	Power supply terminal block	Rack: rigid or flexible cable with end piece with cross section 1 ² to 1.5 ² Wall-mounted: rigid wire 1 ² to 1.5 ² bared 6 mm.
	Other terminals	Cross section 1.5 ² maximum, bared 6 mm.
	Electrical isolation	Class 1.
	Mains power supply system	TT or TN system.
Relays	Control of 3 relays	Programmable in weekly or annual mode
	Control circuit (relay) isolation	Galvanic isolation.
	Circuit operating voltage	Either SELV* or LV** with common phase (230 V maximum between the 2 circuits).
	Relay breaking capacity	240V AC 1A.
	Usefulness of indicator light (of each circuit)	1) Lit when contact closed. 2) Used to indicate the current circuit programming.
	Relay statuses	Standby/work on circuit 3. Normally open on circuits 1 and 2.

Outputs	Synchronisation	Depending on model, on FI, DCF, MSF or GPS antenna.		
	Minute or half minute parallel polarised impulse distribution	One 24 V 1 A output programmable in minutes, half minutes or seconds in local time or 24 V 1A LV power supply.		
	D1D2 distribution	One output (D1 D2 uses the relays of circuits 1 and 2).		
	AFNOR coded time distribution	One output, standard NFS 87 500A (no programming is necessary) (SELV).		
Mechanical	Protection index	Wall-mounted : IP41 / Rack : IP 20		
	Operating temperature	0 to 50°C		
	Keypad locking	By access code		
	Dimensions	WALL-MOUNTED version	19" RACK Version	
		Width	220 mm	483 mm (1 width)
Height		322 mm	44 mm (1 U)	
Depth		83 mm	200 mm	
Weight	0,8 kg	1,4 kg		

* SELV: safety extra low voltage (voltage < 42.4 V peak or 60 V continuous).

**LV: low voltage > 42.4 V peak or 60 V continuous.

15) What to do if ...? Check that ...

What to do if ...?	Check that ... (see page 5 for references)
The green LED does not light up when the unit is switched on.	<ul style="list-style-type: none"> >Check that the mains is present (D). >Check that the terminal strips (K) are correctly positioned on the printed circuit. >Check that the flat cable (Q) of the keypad is correctly connected on the terminal strip on the printed circuit.
The mains is present but there is no secondary voltage.	<ul style="list-style-type: none"> >Check that the terminal strip is correctly positioned on the printed circuit. >Replace the transformer after checking that there is no short-circuit.
No message appears when the unit is switched on.	<ul style="list-style-type: none"> >Check that the flat cable (Q) of the display is correctly connected on the terminal strip on the printed circuit.
Nothing happens when a key is pressed on the keypad.	<ul style="list-style-type: none"> > It is possible that the key has not been pressed long enough. >Check that the flat cable (Q) of the keypad is correctly connected on the terminal strip on the printed circuit. > Check that the keypad is not locked (incorrect access code entered).
With an antenna connected, the "radio" pictogram is still flashing.	<ul style="list-style-type: none"> >Check that a radio synchronisation antenna is connected to the unit and that its LED is flashing. > Wait at least 4 minutes.
Drift of the time base.	<ul style="list-style-type: none"> >Refer to the section on setting the time base drift (page 26).
Considerable drift (> 0.5 seconds per day) of the time base.	<ul style="list-style-type: none"> >Send the equipment back to the BODET maintenance department.

16) Installation examples

16.1 Setting a 24V time distribution

The 24V time distribution must be connected to the terminals 14 and 15.

Apply the power to the SIGMA.

Enter the technician menu (see page 23).

Enter the “time output” menu.

Select with the navigation keys :

- the type of distribution (minute, ½ minute, second),
- the impulse duration,
- check that all the slave clocks indicates the same time and enter this time.



```
Impuls 01:MIN 1.2s ⚡
ARRET 00:00 P+ ok
```

Then, select “START” and validate with the key . The slave clocks will get automatically synchronised with the time of the SIGMA.

16.2 Setting a DHF time distribution

The DHF transmitter must be connected (see page 39).

Apply the power to the SIGMA.

Enter the technician menu (see page 23).

Enter the “time output” option.

Select with the navigation keys :

- the transmission power (25, 125, 500mW),
- the channel (see instruction manual of the DHF transmitter),
- configure the SIGMA in INIT mode (all the DHF receivers (slave clocks, repeaters...) must also be in INIT mode),
- when all the slave clocks are synchronised, configure the SIGMA in START mode (automatic after 4 hours).



```
DHF 03 : INIT ⚡
125mW canal:1 ok
```

Then, validate with the key .

Nota: when adding DHF receivers, you do not have to enter the technician

menu, the “Add DHF receivers” option in the user menu is sufficient.

16.3 Programming a RHF circuit

Install the wireless relay.

Configure the address of the corresponding RHF circuit using the DIP switches from 5 to 8 (default address is 60).

Nota : several wireless relays can have the same address as long as control is the same (e.g. control of outdoor lighting).

In the technician menu, assign the relay, see page 29.

Program the circuit, see page 17.

Place the master clock in INIT mode, see page 12.

Check good running with the key .

Nota: commands are sent to the wireless relays every hour, any time the programming is modified and when leaving the menu.

The update of the schedule is sent every hour to the wireless relays. A wireless relays save a 2-hour schedule. It must receive an update at least once both hours.

In the case of a bad reception, at the end of two hours of non-reception, no more steps are executed and the led of the relay becomes red.

16.4 Install an option board

Switch off the SIGMA, open it, see page 40.

Install the option board in the slot, fix it with the screws provided and put the label in front of it.

Connect the output or input lines of this board.

Close the SIGMA and switch it on.

For an option board of time synchronisation, see “Time synchro” technician menu (see page 24).

For an option board of time distribution, set the lines to “Start” in the “Time outputs” technician menu (see page 27).

Remark: in the “Time outputs” technician menu, “DEL” mode is used only to uninstall an option board from the master clock.

16.5 Set a 24V TBT output

The 24V must be connected to the terminals 14 and 15.

Switch on the SIGMA.

Enter the technician menu (see page 23).

Enter the “Time outputs” menu.

Use the navigation keys to select :

TBT24V.



Impuls 01: TBT24V ⚡
STOP ok

Caution : this output is protected ; if the current is too high, an alarm will go off and the output will stop supplying 24V.