

Style 5
Style 7

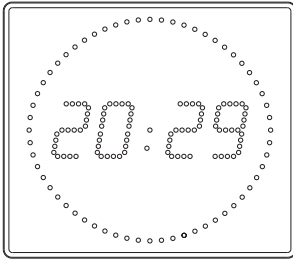

INDEP. QUARTZ
MIN.-1/2 MIN.
Synchro radio

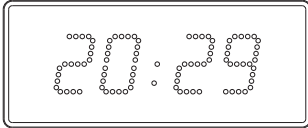
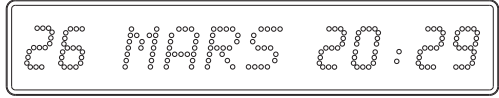
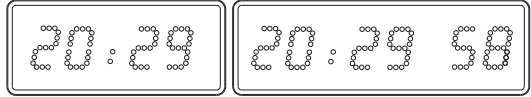
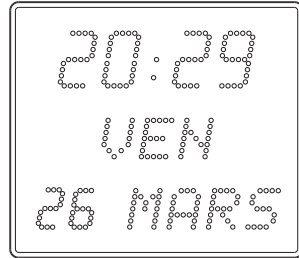

INSTALLATION AND OPERATING INSTRUCTIONS



B.P. 1
49340 TRÉMENTINES
FRANCE
Tél. : 02 41 71 72 00
Fax : 02 41 71 72 01
www.bodet.com



Réf.: 605808 F

When receiving goods please check nothing is broken otherwise make a claim near shipping company.

Table of contents

ENGLISH	4
1) INITIAL CHECKS	4
2) ELECTRIC POWER SUPPLY INSTALLATION FOR <i>STYLE</i> CLOCKS	5
3) LINK-UP TO A TIME DISTRIBUTION NETWORK	6
4) CONNECTION OF A RADIO SYNCHRONIZATION RECEIVER	6
5) CONNECTION OF A TIMER CONTROL UNIT TO A <i>STYLE 5 S</i> CLOCK	7
6) LOCATION OF THE “SELECT” AND “+” KEYS	8
7) CONFIGURATION	8
8) TIME-SETTING	12
9) DISPLAY BRIGHTNESS ADJUSTMENT	14
10) DATA BACK-UP	14
11) CLEANING	14
APPENDIX : TECHNICAL FEATURES	14

1) INITIAL CHECKS

- In its original packaging, each *Style* clock is supplied clipped onto its wall holder, together with a cleaning kit (impregnated anti-static cloth), a bag containing 3 screws, 3 rawplugs and one 33 Ohm resistor. This resistor is only used for French serial time distribution.

- Unclip the holder (A) : insert your finger at the base of the opening (B), then pull firmly towards you.

- **IMPORTANT** : product information.

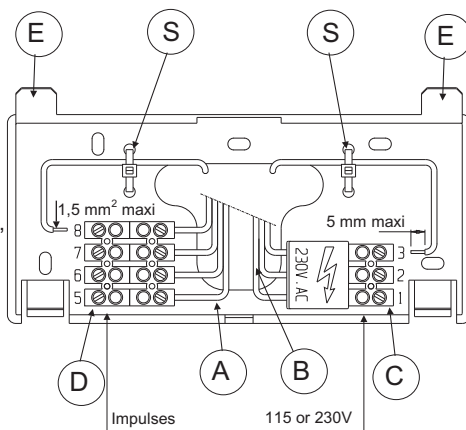

Two descriptive labels are affixed to the back of the clock, and visible once the holder has been removed. One of them indicates the following information : clock model (*Style* 5, *Style* 7, ...), power supply, type of clock (refer to information below), other information such as the colour for example. Check that the *Style* clock which has been delivered to you is suitable for the intended mode of operation.

IND.-M-1/2M

The clock can be configured for independent operation, or linked up to a time distribution network controlled by a master clock which delivers minute or half-minute impulses.

SYN. EXT.

The clock can be configured for independent operation, or radio-synchronized using a radio receiver, P/N 907025 (France-Inter) or P/N 907026 (DCF). Only the *Style* 7, *Style 7 ellipse* and *Style 7 date* clocks are available in the radiosynchro version.

Any operation not complying with the present instructions can cause irreversible damage to the clock, and renders the warranty invalid.

The present instruction booklet concerns “Ind.- Impuls” and “Ind.- Radio” clocks. For other models, please refer to the appropriate instruction booklet.

Security rules :

The installation and the maintenance service of this clock has to be done by skilled person.

The installation has to be done according to the standard (NFC 15-100 for France).

You need a 4A break circuit before the power supply.

This break circuit has to be turned off in case of maintenance service.

The power supply has to be turned on only after fixing the clock.

Connection according to the installation instructions TN or TT.

2) ELECTRIC POWER SUPPLY INSTALLATION FOR *STYLE* CLOCKS

- Wall mounting : Fix the holder (A) in the chosen position, using the 3 rawlplugs and 3 screws supplied.

- Mounting on vertical bracket or ceiling bracket : the holder (A) fits the single-sided mounting bracket, P/N 936301, the double-sided mounting bracket, P/N 936300, and the double-sided chain suspension P/N 936302. Use the tapping screws supplied with the bracket.

- A flush-mounting holder for *Style 5 s* clocks is also available, P/N 936306. This type of mounting is particularly suitable for operating theatres in hospitals and clinics.

- Remove the black protective cover (covering the terminal strip (C)). Connect up the 115 or 230 Volt 50/60 Hz mains supply line to the terminal strip : Live and Neutral on terminals 1 and 2 (Wire max. section : 1.5 mm² with 5 mm bare). As this clock is classified on the 2nd level, the connection to the earth is not required because it is not used. Put the protective cover back in place. Lock the wires with collars (S).

N.B.: *Style* clocks have been designed for a 115 or 230 Volt \pm 10 % mains supply. This clock is protected by a fuse (F1).

If the clock belongs to a time distribution network, or if it must be connected to a France-Inter or DCF radio receiver, please proceed as explained in chapters 3 to 5.

- Clip the clock onto its holder, by introducing the two studs (E) into the two corresponding openings made in the back of the clock, and then by pressing firmly on the lower part of the clock, until it clicks into place. Take care not to jam the cables during this operation.

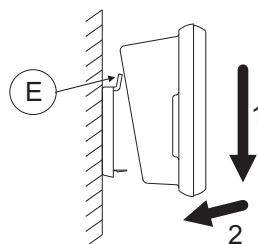

- The clock can be subsequently unclipped from its holder, by pulling the lower part of the clock firmly towards you, and then by removing it via the top.

- You may now configure your *Style* clock, set time and date, and adjust the display brightness. Please refer to Chapters 6 to 9.

- Remove the protective sheet from the front panel and use the anti-static cloth to clean the clock.

- If the display does not change check that the operating mode chosen is indeed "Ind" (Chapter 7).

3) LINK-UP TO A TIME DISTRIBUTION NETWORK

- Connect up the 115 or 230 V 50/60 Hz mains supply (Chapter 2).

PARALLEL DISTRIBUTION WITH REVERSED POLARITY

(minute // 12-24-48 Volt, half-minute // 24 Volt)

- Check that the clock's descriptive label displays the wording "Ind.- Impuls."
- Connect the impulse line to terminals 6 and 7 on the terminal strip (D).
- Select the impulse type (minute or half-minute) and the display mode (Chapter 7).
- Set the time on the clock (Chapter 8).

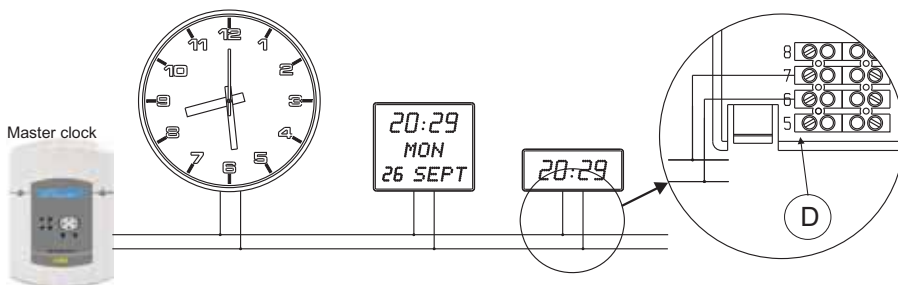

4) CONNECTION OF A RADIO SYNCHRONIZATION RECEIVER

- Use a France-Inter (P/N 907025), or a DCF (P/N 907026) radio receiver.
- Only the *Style 7*, *Style 7 ellipse* and *Style 7 date* clocks are available in the radio-synchro version ("Ind.- Radio" descriptive label).
- Connect the radio receiver to terminals 5 and 6 on the terminal strip (D). There is no polarity to be respected.

Then following the instructions given in Chapter 7 ("Configuration") :

- Select the "Ind" operating mode.
- Choose the display mode and summer / winter (automatic daylight saving) time changeover.
- If the quality of reception is good, the time on the clock will be set automatically to the right time after **4 minutes**. In zones where the radio signal is difficult to receive, set the time on the clock manually (Chapter 8), pending radio synchronization (generally, reception is better at night).

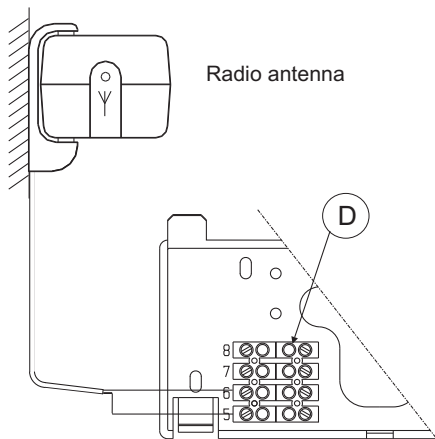

5) CONNECTION OF A TIMER CONTROL UNIT TO A STYLE 5 S CLOCK

The timer control unit, P/N 936400, operates in count-up or count-down modes. Its various functions include : Start, Stop, Split Time, triggering of a relay at the end of the countdown or count up operation (to stop at a pre-programmed time). The timer control unit can control up to ten *Style 5 s* clocks.

Style 5 s clocks are equipped with a separate terminal strip (F), independent of the two terminal strips (C) and (D) fixed on the mounting.

- Connect up the timer control unit to the terminal strip (F), using a 4 core cable (T-, T+, and two wires for the 12 Volt supply).

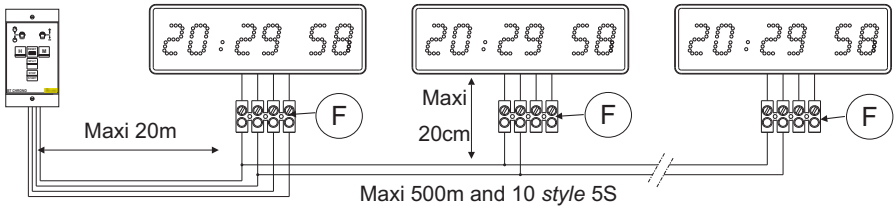
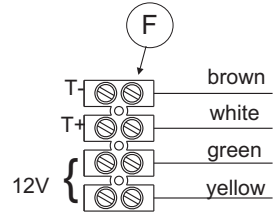

- Chaining several *Style 5 s* clocks on the same timer control unit can be achieved by connecting all T- terminals together, as well as all T+ terminals together, using a 2 core telephone cable.

The first clock remains connected to the timer control unit through a 4 core cable.

- For further information, please refer to the instructions relating to the timer control unit.

6) LOCATION OF THE “SELECT” AND “+” KEYS

- These two keys are located on the back of the clock, on the right on *Style 5*, *Style 5 s* and *Style 5 date* clocks, on the left on *Style 7*, *Style 7 ellipse* and *Style 7 date* clocks.
- The “**Select**” key is above the “+” key.

7) CONFIGURATION

- a -To access this menu, first press the “**SELECT**” key, then keeping the “**SELECT**” key pressed down, press the “+” key for 3 seconds.

Caution : the seconds automatically reset to zero upon accessing the “configuration” menu.

- The clock displays the previously selected operating mode :

Operating Mode	Display	
	<i>Style 5, 5 s, 7 and 7 ellipse</i>	<i>Style 5 date and 7 date</i>
Independent	IND	IND.
Minute slave movement	MIN	MIN
Half-minute slave movement	1/2M	1/2M
Calibration	CAL	CAL.

Select the required operating mode using the “+” key.

Remark : make sure that the mode selected matches both the desired mode of operation (e.g. minute slave movement), and the clock’s descriptive label (e.g. “Ind.-Impuls.”).

When the chosen operating mode (e.g. “Ind”) appears on the display, press the “**Select**” key to enter your selection. Avoid entering the Calibration mode, reserved for the manufacturer.

Note : It is possible to exit this menu at any time. All you have to do is to press the “**Select**” key, and then with the “**Select**” key pressed down, press the “+” key. Release the two keys afterwards.

- b -*Style 5*, *Style 5 s*, *Style 7* and *Style 7 ellipse* clocks

Using the “+” key, select the type of display required from one of the following three options :

- The current time blinks (e.g. 20:29). This selection corresponds to the most frequent mode of operation : permanent time display.

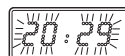

- "31 12" blinks : this selection corresponds to an alternate display of the time and of the date (day-month).



- "12 31" blinks : this selection corresponds to an alternate display of the time and of the date, in the USA manner (month - day).

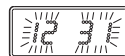

- "52" blinks : this selection corresponds to an alternate display of the time and of the week number.



Enter by pressing the "**Select**" key. Please proceed further with paragraph e

c -Style 5 date and Style 7 date clocks



The language blinks :

F	= French	N	= Norwegian
GB	= English	S	= Swedish
SP	= Spanish	DK	= Danish
D	= German	SF	= Finnish
I	= Italian	CA	= Catalan
P	= Portuguese	BA	= Basque
NL	= Dutch	GA	= Gallego

- Select the desired language using the "+" key, then enter by pressing the "**Select**" key.

- Using the "+" key, choose any second language as required for alternate display. If you select "- -", only the first language will be used. Enter by pressing the "**Select**" key.

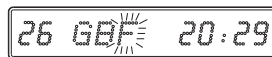

d -Style 7 Date clocks

Using the “+” key, select the type of central display required from one of the following three options :

- Day of the week (MON, TUE, ..., SUN)

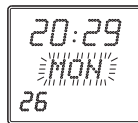

- “52”. This selection corresponds to a week number display.

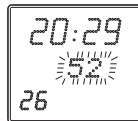

- “365”. This selection corresponds to a Julian date display.



Enter by pressing the “**Select**” key. If “Day of the week” has been chosen, or if an alternate display with 2 languages has been selected, please proceed directly with paragraph e .

Using the “+” key, select whether the central display is to be permanent or alternate :

- The display chosen previously (week number or Julian date) will be permanent.

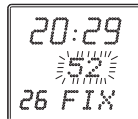

- The display chosen previously (week number or Julian date) will alternate with the day of the week.

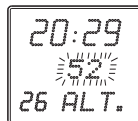

Enter by pressing the “**Select**” key.

e -Summer / Winter time changeover selection

The summer / winter (automatic daylight saving) time changeover can only be made automatically on independent or radio-synchronized clocks.

It will have no effect in the case of a (minute or half-minute) slave clock : the *Style* clock will always be controlled by the impulses delivered by the master clock.

Using the “+” key, select the required country of reference for the summer / winter time changeover.

Country of Reference**Style 5, 5 s, 7 and 7 ellipse**

No changeover	G nt
Europe, except for the United Kingdom	E ur
United Kingdom	Gb
United States + Canada	U SA

Display**Style 5 date and 7 date**

HGMT
 EURO
 UK
 USA

Enter by pressing the **"Select"** key.

Radio synchronized clocks : for any selection but "Europe", it is necessary to set the time manually in the first place (Chapter 8), since your *Style* clock only synchronizes with the minutes and seconds of the radio signal.

f -The time difference blinks (00 by default).

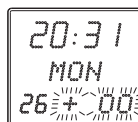
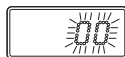

This menu allows to set a time difference between the displayed time and the received time (radio-synchronization message). Hence, it will be only used for a radio-synchronized *Style* clock, properly connected to a France-Inter or DCF radio receiver, with country of reference = Europe.

- Select the time difference required, from 15 h to +15 h, using the "+" key.

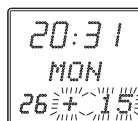
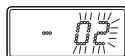

The selected time difference will be only effective after 3 correct receptions of the time message, i.e. about 4 minutes.

If the **"Select"** key is pressed, you exit the "configuration" menu. The clock then returns to the display mode corresponding to its normal use.

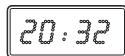

8) TIME-SETTING

- a -When on the normal display, or on the "Bat" display following a prolonged mains power failure, press the "Select" key.

The clock displays the time, and the minutes blink.

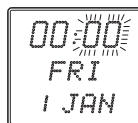
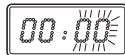

- Pressing the "+" key makes it possible to increment the minutes, with a rapid scrolling facility when the key is pressed down for a long time.

Each time the "+" key is pressed, the seconds are reset to zero.

Accurate time setting of a clock operating independently :

- Use a "reference" time (e.g. radio or TV broadcast or the speaking clock)
- Using the "+" key, set the *Style* clock to the current minute.

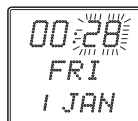
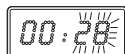

For example, if the reference time is "20 hours 28 minutes and 20 seconds", display "28" using the "+" key.

- When the reference time reaches "20 hours 29 minutes 00 seconds", simultaneously press the "+" key. This makes it possible both to increment the "minutes" digit (and therefore to go from "28" to "29"), and to reset the seconds to zero.

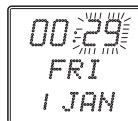
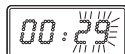

When the value required for the minutes has been set, press the "Select" key.

- b -The minutes stop blinking and the hours blink.

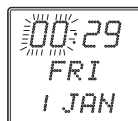
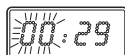

- Set the hours using the "+" key, then enter by pressing the "Select" key.

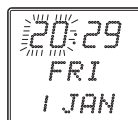
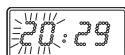

Note : It is possible to exit this menu at any time. All you have to do is to press the "Select" key, and then with the

“Select” key pressed down, press the “+” key. Release the two keys afterwards.

c -The clock displays “24 H” (time display from 0:00 to 23:59) or “12AM” (UK/USA display from 1:00 to 12:59).

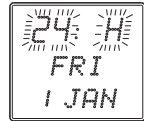
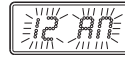

- You can choose one of these options using the “+” key. Enter by pressing the “Select” key.

d -The year blinks.

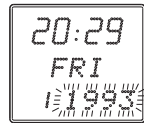
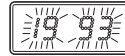

- Select the current year (from 1993 to 2092) using the “+” key, then enter by pressing the “Select” key.

e -The month blinks.

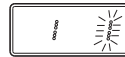

- Select the current month using the “+” key, then enter by pressing the “Select” key.

f -The day of the month (1 to 31) blinks.



- Select the day of the month using the “+” key, then enter by pressing the “Select” key.

This allows you to exit the “time-setting” menu.

9) DISPLAY BRIGHTNESS ADJUSTMENT

- The display brightness can be adjusted when the *Style* clock is in normal operating mode, i.e. when the clock is neither in the “configuration” menu, nor in the “time-setting” menu.
- By pressing the “+” key several times in succession, you can directly select the level of display brightness most suited to the level of ambient lighting, from the four brightness levels proposed.

10) DATA BACK-UP

- *Style* clocks possess a permanent data back-up facility which permits the clock to store all the configuration parameters and display selections, even in the event of a prolonged mains power failure.
- On the other hand, the date and the time can be “lost” following an exceptionally long mains power failure (i.e. one lasting more than one week) ; in which case, once the mains power supply is restored, the clock displays “Bat”. This occurs notably with a new clock.
- When the clock displays “Bat”, it is necessary to reset the time on the clock (Chapter 8). However, time and date are reset automatically on a radio-synchronized clock linked up to a radio receiver, with reference country for Summer / Winter time changeover = Europe.

11) CLEANING

Use an anti-static cleaner similar to that supplied in the original packaging.
Never use cleaning spirits, acetone or any other solvents which are likely to damage the casing and the filter of your *Style* clock.

APPENDIX : TECHNICAL FEATURES

The *Style* clocks are compliant to the electromagnetic standard 89/336/CEE.

They are designed for indoor use.

They are compliant with the following european standards :

- NF EN 55022 (December 1994).
- NF EN 50082-1 (june 1992).
- EN 60950.

- Power supply : 115 or 230 V \pm 10 % 50/60 Hz.
- Slave clock consumption on a parallel network : 6 mA at 24 V.
- Date and Time back-up when mains is down : 1 week.
- Other data back-up : permanent.
- Operating temperature : 0 to 50°C.
- Protection index : IP30.

These clocks are protected by a fuse (F1).

<i>Style</i> 5	<i>Style</i> 5S and <i>Style</i> 7	<i>Style</i> 5D, <i>Style</i> 7D and 7E
0,5 A slow acting	0,8 A slow acting	4 A slow acting

Style 5

- Size (in mm) :
- Weight : 0,8 kg
- Maximum nominal current : 40 mA

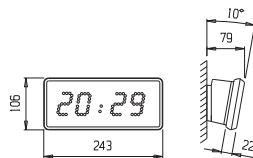

Style 5S

- Size (in mm) :
- Weight : 1 kg
- Maximum nominal current : 55 mA



Style 5D

- Size (in mm) :
- Weight : 1,6 kg
- Maximum nominal current : 100 mA

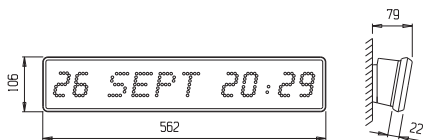

Style 7

- Size (in mm) :
- Weight : 1,1 kg
- Maximum nominal current : 65 mA

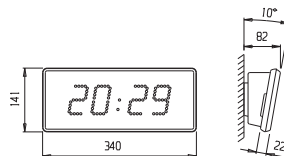

Style 7D

- Size (in mm) :
- Weight : 2,2 kg
- Maximum nominal current : 150 mA

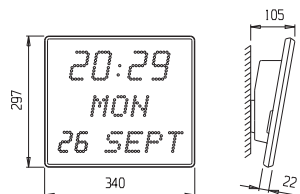

Style 7E

- Size (in mm) :
- Weight : 2,2 kg
- Maximum nominal current : 80 mA

